

## TECHNICAL PROPOSAL

### POP2 ABA7008-SEKOLAH KEBANGSAAN LENGGONG (D-SIDE)

**Company Name** : WabTech Sdn Bhd  
**Company Address** : 101-1, Jalan Metro Sendayan, 71950, Seremban, Negeri Sembilan.  
**Prepared By** : Muhamad Iqbal Aqasha Bin Muzaidi  
**Date** : 20/11/2024

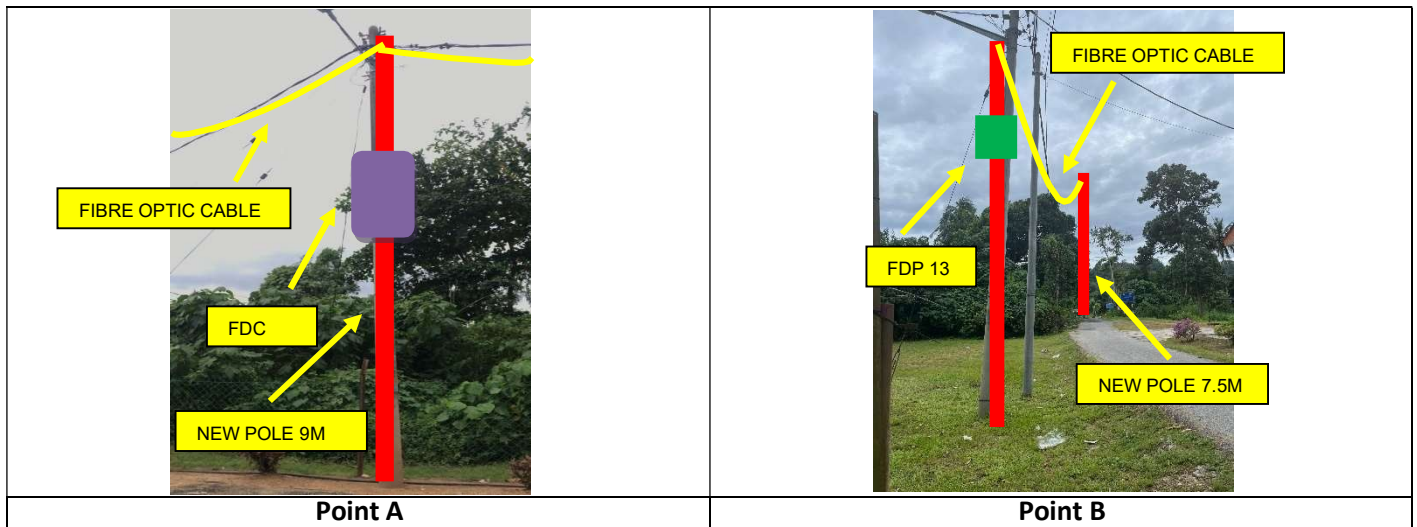

#### Starting Point

**Site / Boundary Name** : SEKOLAH KEBANGSAAN LENGGONG  
**Address** : Jalan Alang Iskandar, Kampung Sira, 33400, Lenggong,  
 Perak.  
**District** : Lenggong  
**Postcode** : 33400  
**State** : Perak  
**GPS Coordinate** : 5.111781, 100.970151  
**LRD** : A

#### End Point

**Site / Boundary Name** : Kampung Lrg Abadi  
**Address** : Jalan Kampung Lrg Abadi  
**District** : Lenggong  
**Postcode** : 33400  
**State** : Perak  
**GPS Coordinate** : 5.115929, 100.975408  
**LRD** : B



PROJEK PENYEDIAAN DAN PENYELENGGARAAN POINT OF PRESENCE (POP)  
FASA 2: HAB INFRASTRUTUK GENTIAN OPTIK BERHAMPIRAN DENGAN  
SEKOLAH, KAWASAN PERINDUSTRIAN, PREMIS KERAJAAN DAN KOMUNITI  
SEKITARNYA OLEH KEMENTERIAN KOMUNIKASI MALAYSIA – ZON UTARA  
(KKMM.400-11/17/132(1))



WABTECH SDN BHD  
(1398387-X)

## 1.0 WORK SUMMARY

NO	PROPOSED DISTANCE AND METHOD	UNIT	QUANTITY
1	Horizontal Directional Drilling (HDD)	m	21m
2	Carriage Way Open Trench (CW)	m	0
3	Grass Verge Open Trenching (GV)	m	0
4	Micro Trenching (MT)	m	0
Total			

NO	OTHER INFORMATION	UNIT	QUANTITY
1	Installation of Short Span ADSS Fibre Cables	m	2161m
2	Install New Pole	ea	58
3	Install New JRC7 Manhole	ea	2
4	Install GI Riser 100mm	ea	2
5	Install Fiber Distribution Point and Closure (Splicing, Termination and Testing)	ea	16
6	Estimated Time Required for Completion	days	30



PROJEK PENYEDIAAN DAN PENYELENGGARAAN POINT OF PRESENCE (POP)  
FASA 2: HAB INFRASTRUTUK GENTIAN OPTIK BERHAMPIRAN DENGAN  
SEKOLAH, KAWASAN PERINDUSTRIAN, PREMIS KERAJAAN DAN KOMUNITI  
SEKITARNYA OLEH KEMENTERIAN KOMUNIKASI MALAYSIA – ZON UTARA  
(KKMM.400-11/17/132(1))



WABTECH SDN BHD  
(1398387-X)

## 2.0 LOCAL AUTHORITY SUMMARY

Daerah Lenggong

NO	ITEMS	Owner	Quantity	Distance (m)
1	HDD	JKR	1	21m
		Majlis	-	-
		PDT	-	-
2	New Pole	JKR	16	595m
		Majlis	42	1545m
		PDT	-	-
<b>Total Distance (m)</b>				<b>2161m</b>

### 3.0 SITE PLAN (KMZ)

#### 3.1 Overview Site Area

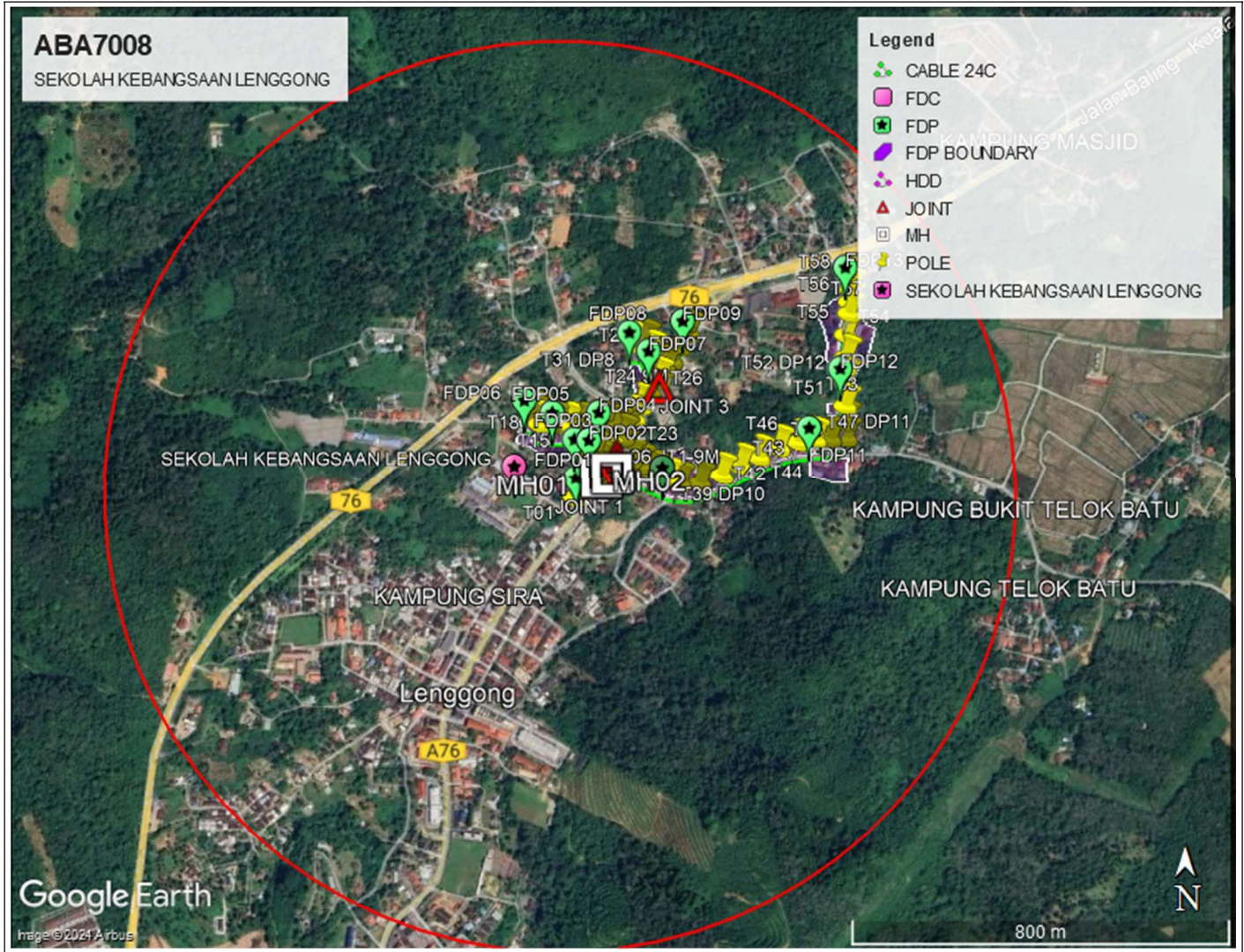

### 3.2 Site Boundary

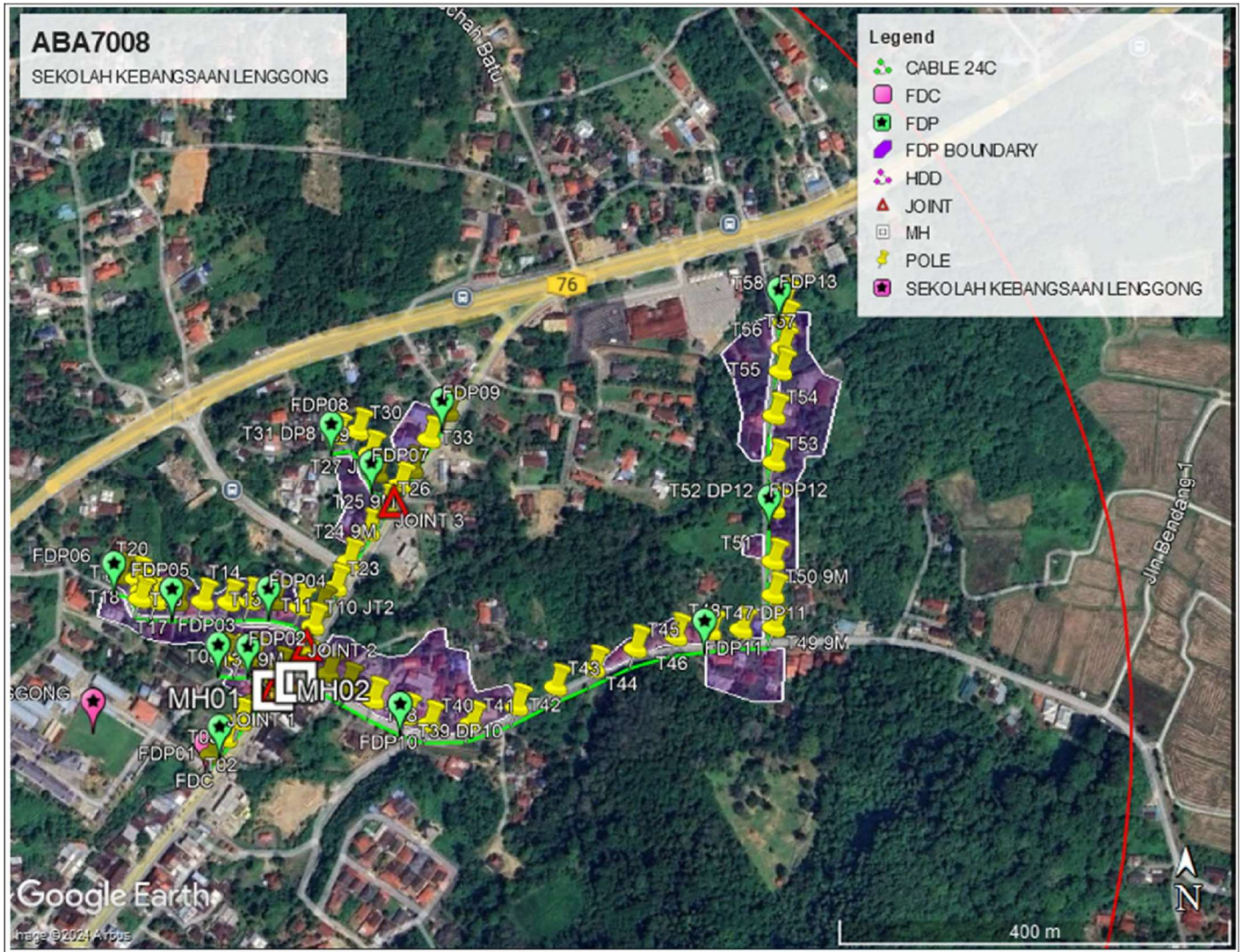

### 3.3 Road Boundary

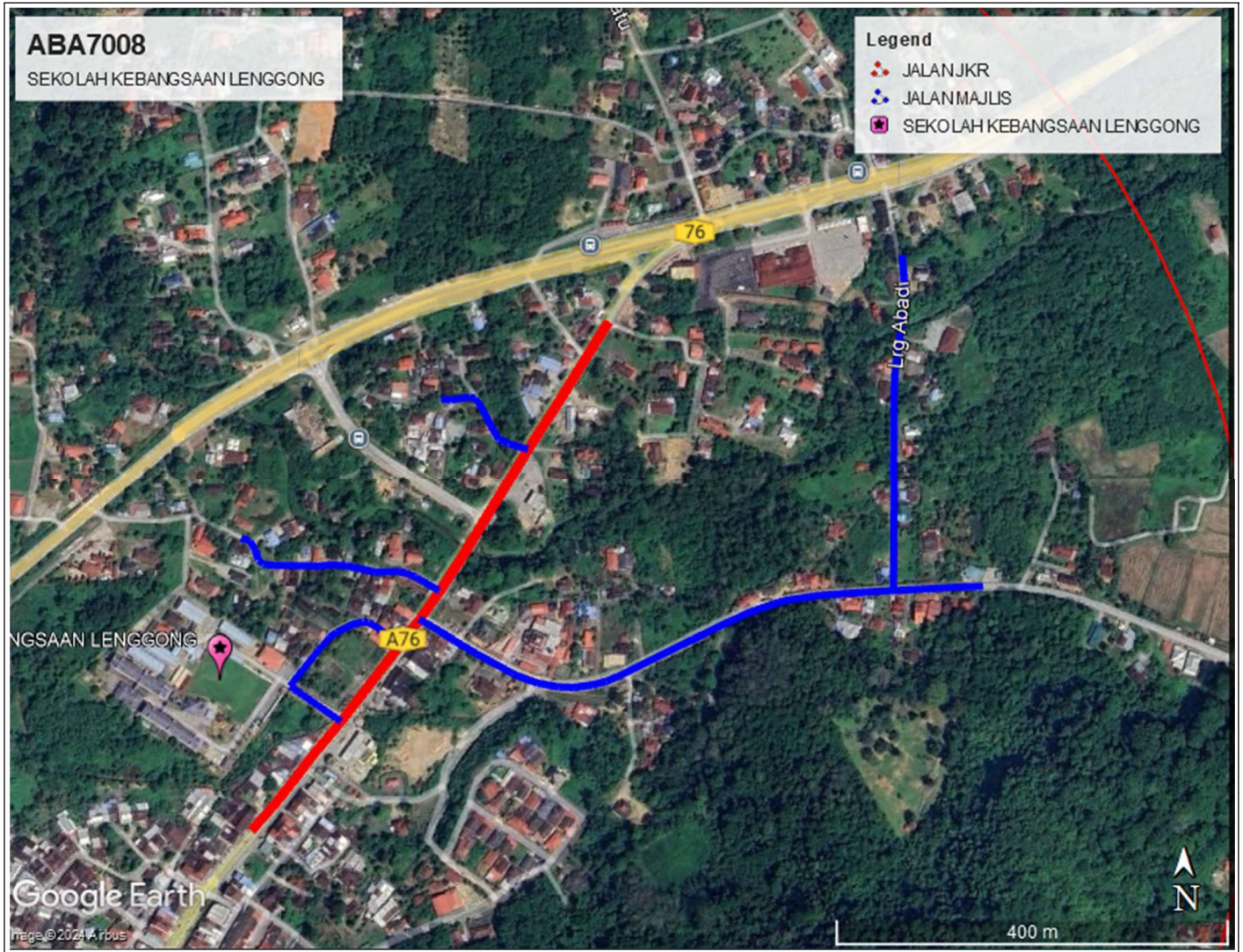

#### 4.0 PROPOSED NEW POLE

Proposed New Pole Coordinate					
No.	Pole Number	Distance (m)	Latitude	Longitude	Local Authority
1	T001	30	5.111776	100.970153	JKR
2	T002	35	5.111917	100.970275	JKR
3	T003	34	5.112080	100.970411	JKR
4	T004	32	5.112267	100.970542	JKR
5	T005	31	5.112437	100.970693	JKR
6	T006	34	5.112553	100.970776	JKR
7	T007	31	5.112660	100.970535	Majlis Daerah Lenggong
8	T008	30	5.112659	100.970408	Majlis Daerah Lenggong
9	T009	25	5.112671	100.970261	Majlis Daerah Lenggong
10	T010	31	5.112955	100.971085	JKR
11	T011	34	5.113121	100.970966	Majlis Daerah Lenggong
12	T012	32	5.113178	100.970723	Majlis Daerah Lenggong
13	T013	30	5.113111	100.970702	Majlis Daerah Lenggong
14	T014	30	5.113164	100.970309	Majlis Daerah Lenggong
15	T015	33	5.113172	100.970067	Majlis Daerah Lenggong
16	T016	34	5.113174	100.969834	Majlis Daerah Lenggong
17	T017	33	5.113161	100.970093	Majlis Daerah Lenggong
18	T018	31	5.113197	100.969490	Majlis Daerah Lenggong
19	T019	38	5.113272	100.969510	Majlis Daerah Lenggong
20	T020	26	5.113380	100.969458	Majlis Daerah Lenggong
21	T021	31	5.113423	100.969311	Majlis Daerah Lenggong
22	T022	34	5.113116	100.971145	JKR
23	T023	31	5.113047	100.971326	JKR
24	T024	32	5.113544	100.971404	JKR
25	T025	34	5.113817	100.971587	JKR
26	T026	34	5.113805	100.971579	JKR
27	T027	32	5.114257	100.971884	JKR
28	T028	35	5.114341	100.971675	Majlis Daerah Lenggong
29	T029	32	5.114538	100.971606	Majlis Daerah Lenggong
30	T030	40	5.114738	100.971500	Majlis Daerah Lenggong
31	T031	34	5.114699	100.971305	Majlis Daerah Lenggong
32	T032	35	5.114392	100.971990	JKR
33	T033	45	5.114483	100.972143	JKR
34	T034	32	5.114910	100.972321	JKR
35	T035	40	5.112629	100.970996	Majlis Daerah Lenggong
36	T036	39	5.112544	100.970870	Majlis Daerah Lenggong
37	T037	40	5.112406	100.971394	Majlis Daerah Lenggong
38	T038	40	5.112277	100.971629	Majlis Daerah Lenggong
39	T039	40	5.112131	100.971933	Majlis Daerah Lenggong



PROJEK PENYEDIAAN DAN PENYELENGGARAAN POINT OF PRESENCE (POP)  
FASA 2: HAB INFRASTRUTUK GENTIAN OPTIK BERHAMPIRAN DENGAN  
SEKOLAH, KAWASAN PERINDUSTRIAN, PREMIS KERAJAAN DAN KOMUNITI  
SEKITARNYA OLEH KEMENTERIAN KOMUNIKASI MALAYSIA – ZON UTARA  
(KKMM.400-11/17/132(1))



WABTECH SDN BHD  
(1398387-X)

No.	Pole Number	Distance (m)	Latitude	Longitude	Local Authority
40	T040	40	5.112058	100.972147	Majlis Daerah Lenggong
41	T041	40	5.112062	100.972527	Majlis Daerah Lenggong
42	T042	40	5.112092	100.972518	Majlis Daerah Lenggong
43	T043	40	5.112401	100.973307	Majlis Daerah Lenggong
44	T044	40	5.112480	100.973301	Majlis Daerah Lenggong
45	T045	40	5.112743	100.974038	Majlis Daerah Lenggong
46	T046	40	5.112857	100.974415	Majlis Daerah Lenggong
47	T047	40	5.112884	100.974730	Majlis Daerah Lenggong
48	T048	40	5.112941	100.974733	Majlis Daerah Lenggong
49	T049	40	5.112934	100.975315	Majlis Daerah Lenggong
50	T050	40	5.113234	100.975302	Majlis Daerah Lenggong
51	T051	45	5.113289	100.975288	Majlis Daerah Lenggong
52	T052	45	5.114021	100.975314	Majlis Daerah Lenggong
53	T053	45	5.114025	100.975105	Majlis Daerah Lenggong
54	T054	45	5.114885	100.975319	Majlis Daerah Lenggong
55	T055	45	5.115290	100.975378	Majlis Daerah Lenggong
56	T056	40	5.115506	100.975394	Majlis Daerah Lenggong
57	T057	40	5.115632	100.975406	Majlis Daerah Lenggong
58	T058	40	5.115929	100.975415	Majlis Daerah Lenggong

**5.0 SITE PHOTOS - PROPOSED NEW POLE**

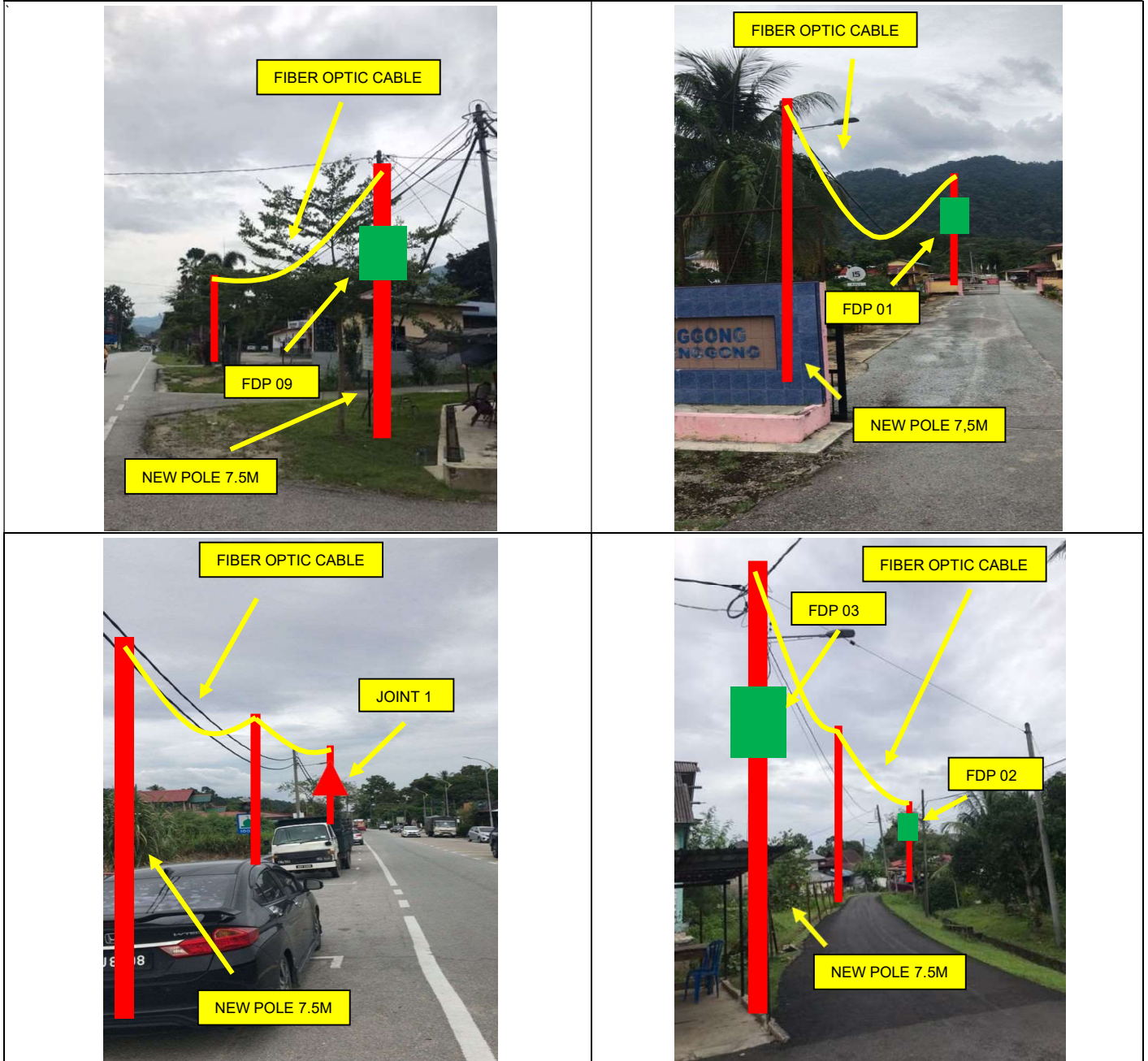

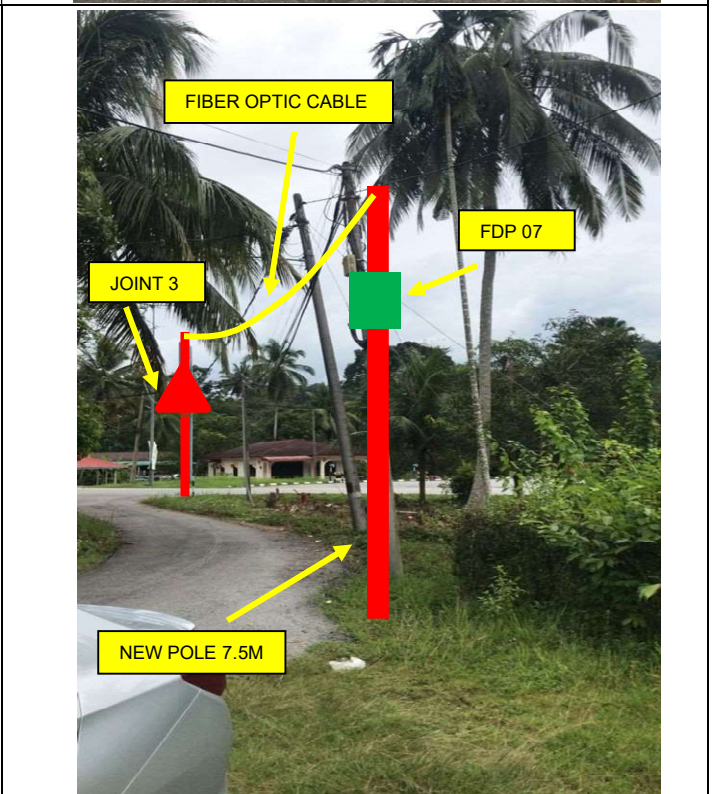
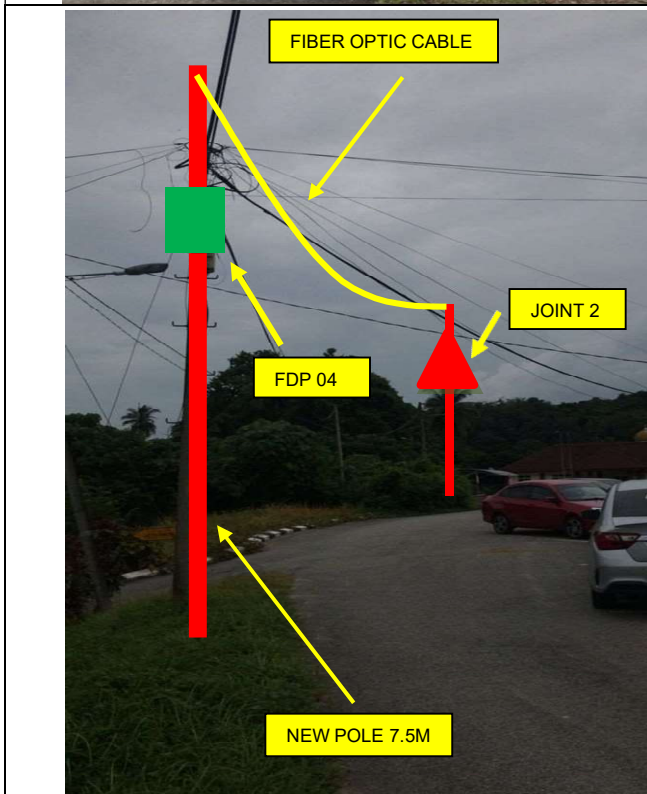
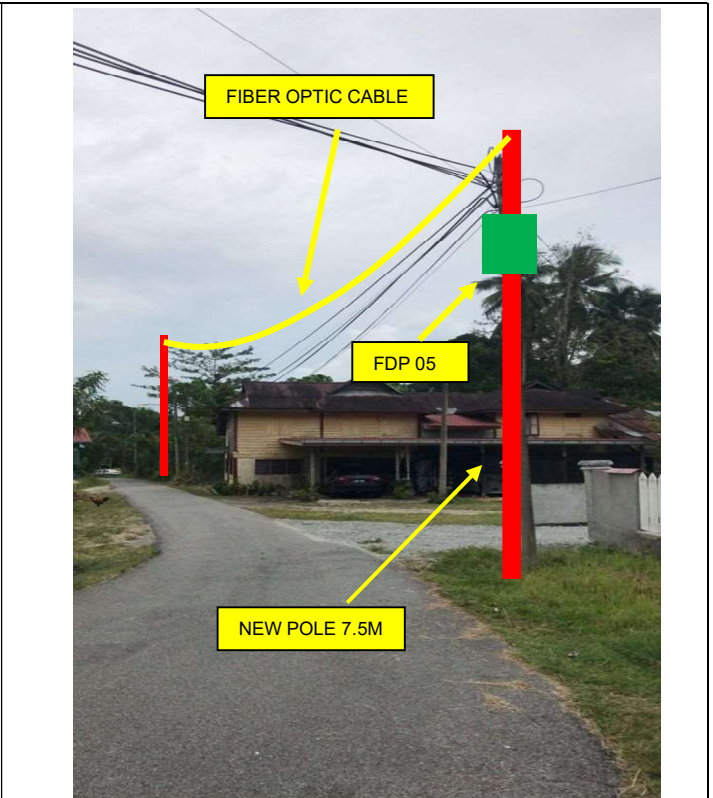
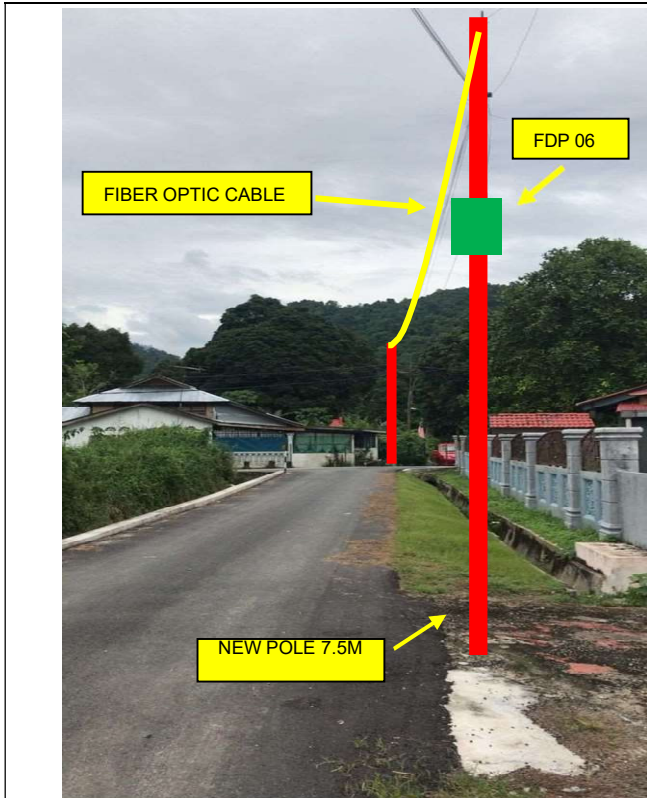

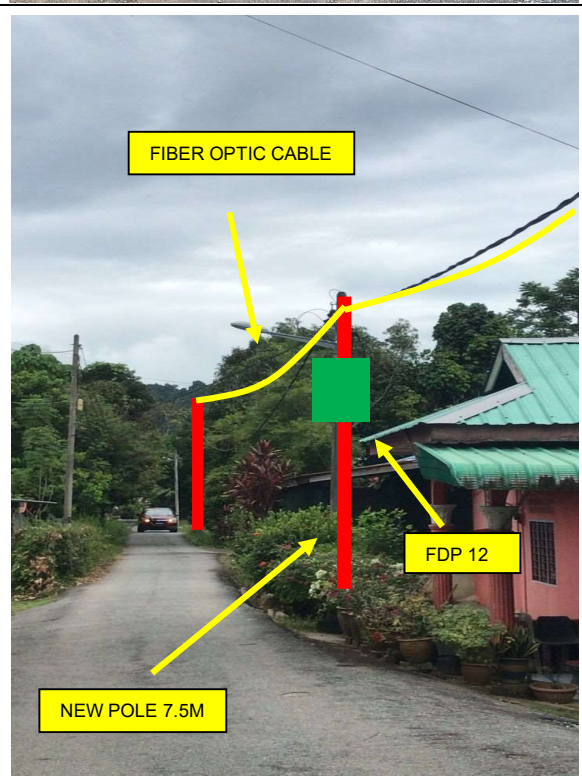
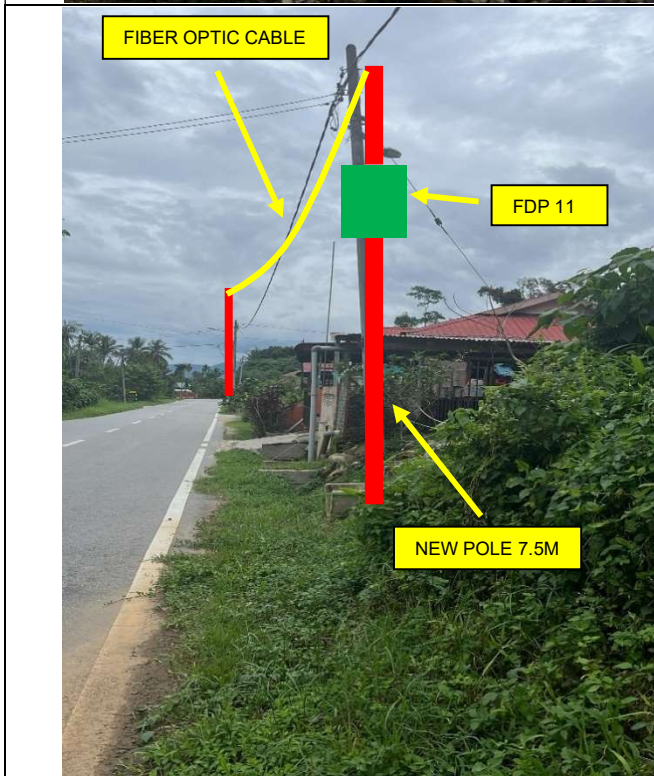
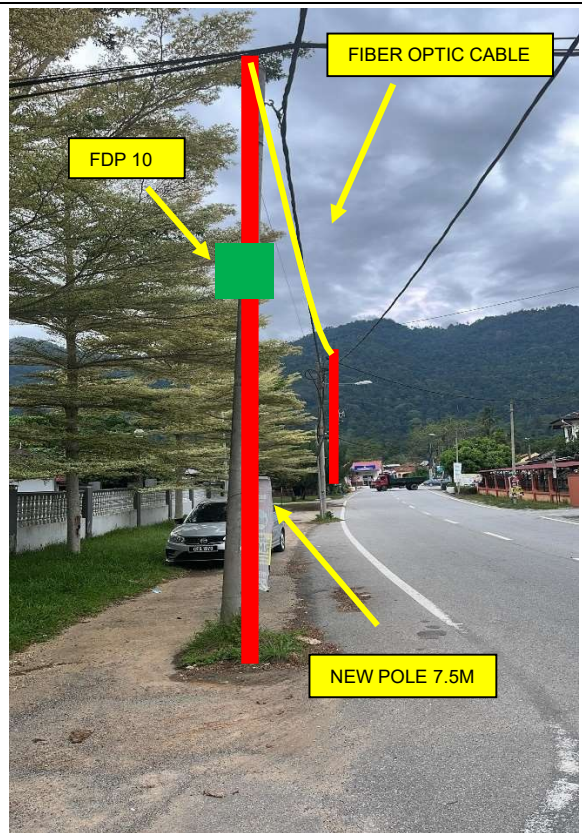
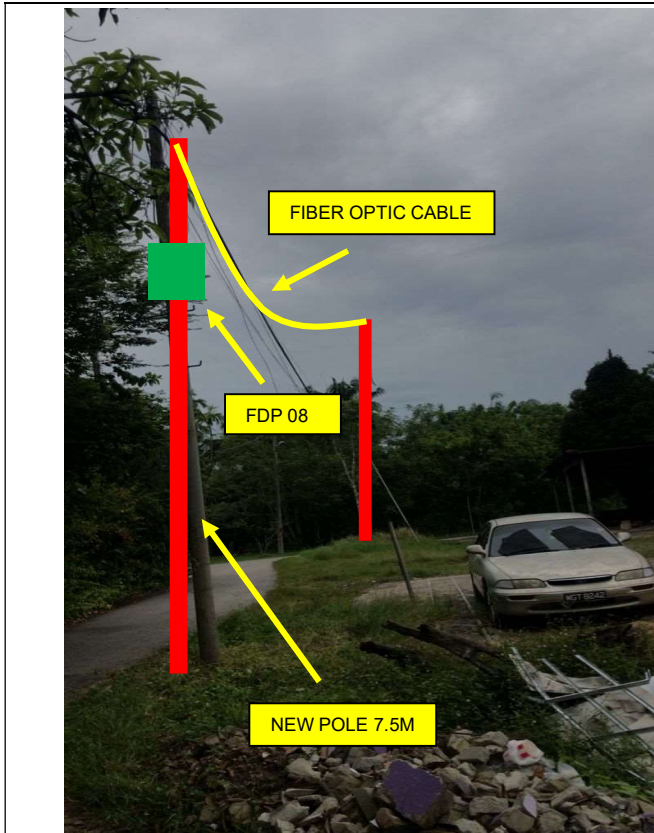

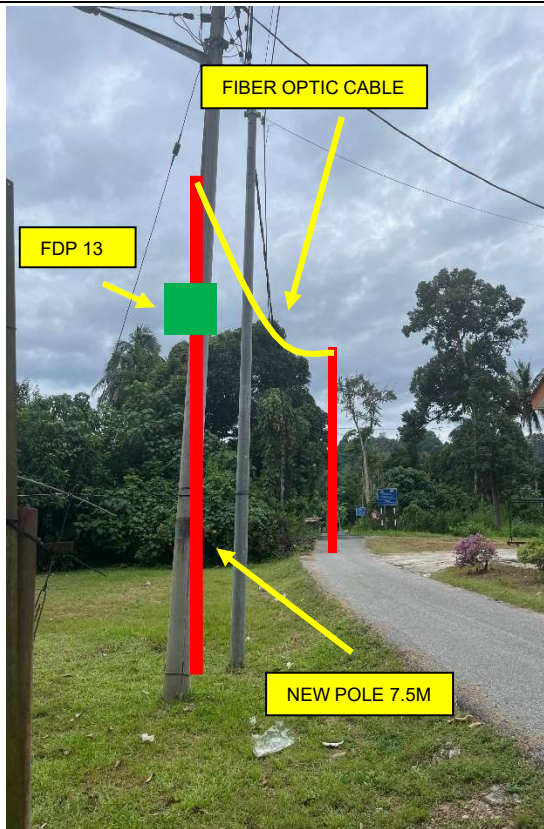



PROJEK PENYEDIAAN DAN PENYELENGGARAAN POINT OF PRESENCE (POP)  
FASA 2: HAB INFRASTRUTUK GENTIAN OPTIK BERHAMPIRAN DENGAN  
SEKOLAH, KAWASAN PERINDUSTRIAN, PREMIS KERAJAAN DAN KOMUNITI  
SEKITARNYA OLEH KEMENTERIAN KOMUNIKASI MALAYSIA – ZON UTARA  
(KKMM.400-11/17/132(1))



WABTECH SDN BHD  
11398387-X

#### 6.0 3<sup>rd</sup> PARTIES DEPENDENCIES

NO	LOCAL COUNCIL / AUTHORITY	REMARK
1	JKR Daerah Lenggong	595m
2	Majlis Daerah Lenggong	1545m

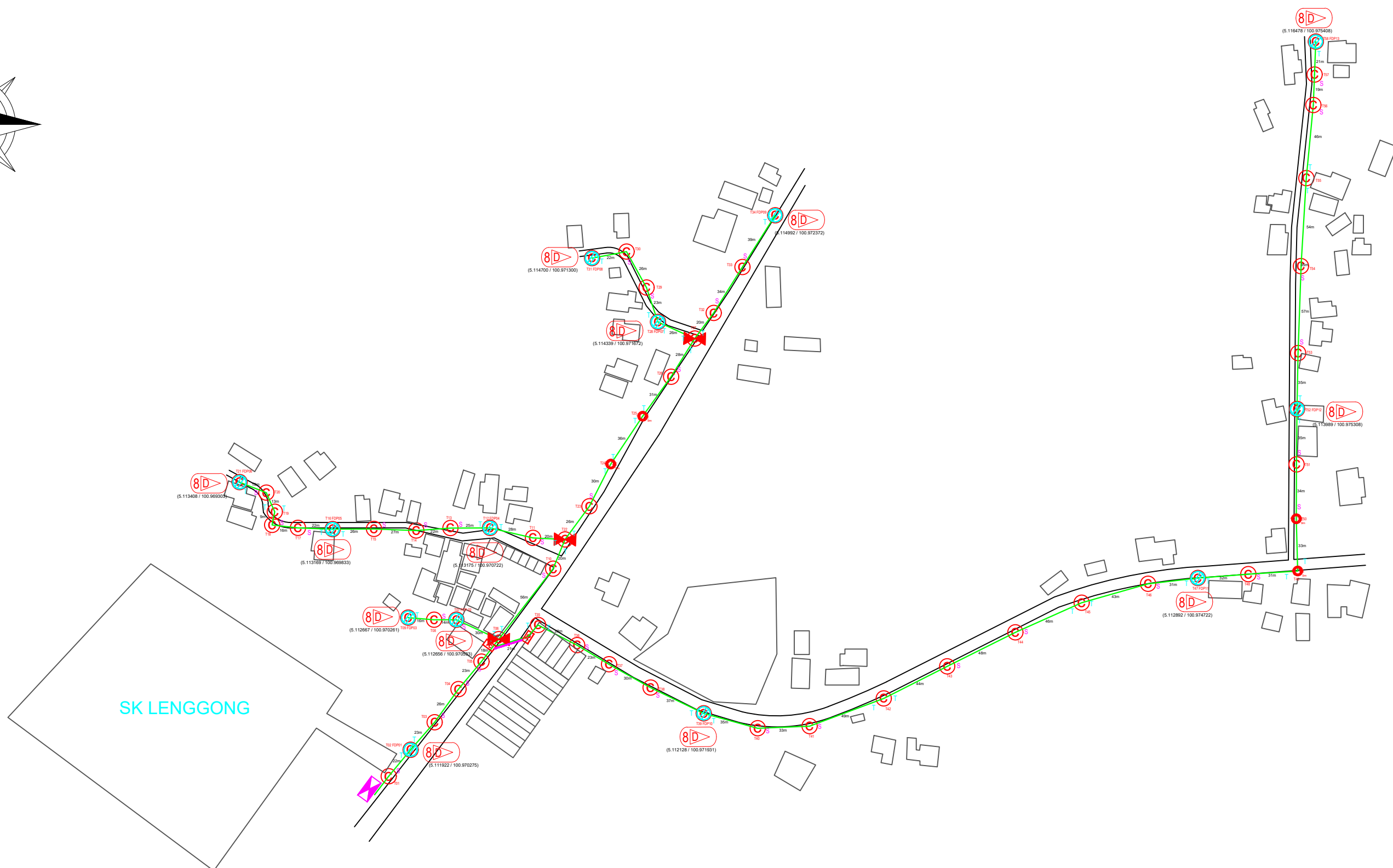
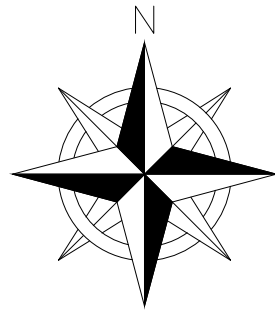

12C FOC	Installed 1:4 / 1:8 splitter	Existing TNB Pole	Pole Ring	13	Micro-Trenching (Meter)	#	Active Outdoor Numbering	CL01	Closure NO.
24C FOC	3440m	Installed Riser	New Manhole (PIT)		Temporary Infra (Meter)	NBD#	FDC NO.	DP1	FDP NO.
48C FOC		FDP with (1:8) splitter	New Manhole(JRC7)	2	FDP Boundary	MH1	MH NO.		
96C FOC		Installed Pole (9m)	Existing Manhole	35	HDD (Meter)	TKS-1	Existing TNB Pole NO.		
144C FOC		Installed Pole (7.5m)	Loop / Coil (Meter)	44	Open Cut (Meter)	T01	New Pole NO.		

ACTUAL HOMEPASS :

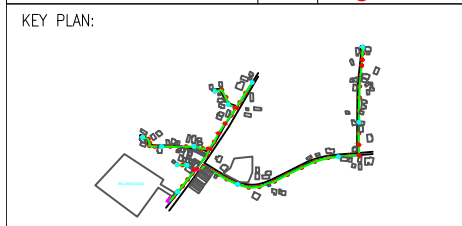

PROJECT OWNER:



KEMENTERIAN KOMUNIKASI DAN DIGITAL

MAIN CONTRACTOR:



PRIVASAT

SUB-CONTRACTOR:



WABTECH SDN BHD (1398387-X)  
101-1, JALAN METRO SENDAYAN 2,  
METRO SENDAYAN, BANDAR SRI SENDAYAN  
71950 SEREMBAN, NEGERI SEMBILAN.  
TEL: +606-6020063  
FAX: (60) 6 602 0063  
E-MAIL: wabgo@wabtech.solutions WEBSITE: www.wabtech.solutions

PROJECT TITLE:  
**CONTRACT FOR THE PROVISION OF SUPPLY, INSTALLATION AND COMMISSIONING OF FTXX NETWORK INFRASTRUCTURE - POP 2 PROJECT (D-SIDE) - FOR ABA7008 - SK LENGGONG**

DRAWING TITLE:  
**CONSTRUCTION DRAWING - SK LENGGONG**

PROJECT PHASE:  
**SK LENGGONG**

Design By : M. AFIQ HAKIMI	Date : 29 NOVEMBER 2024
Drawn By : M. AFIQ HAKIMI	Scale :
Checked By : (WABTECH PIC)	Job Number :
DRAWING NUMBER :	Sheet : 1 / 1
THIS PRINT AND ITS COPYRIGHT ARE THE PROPERTY OF WABTECH SDN BHD	
Size :	

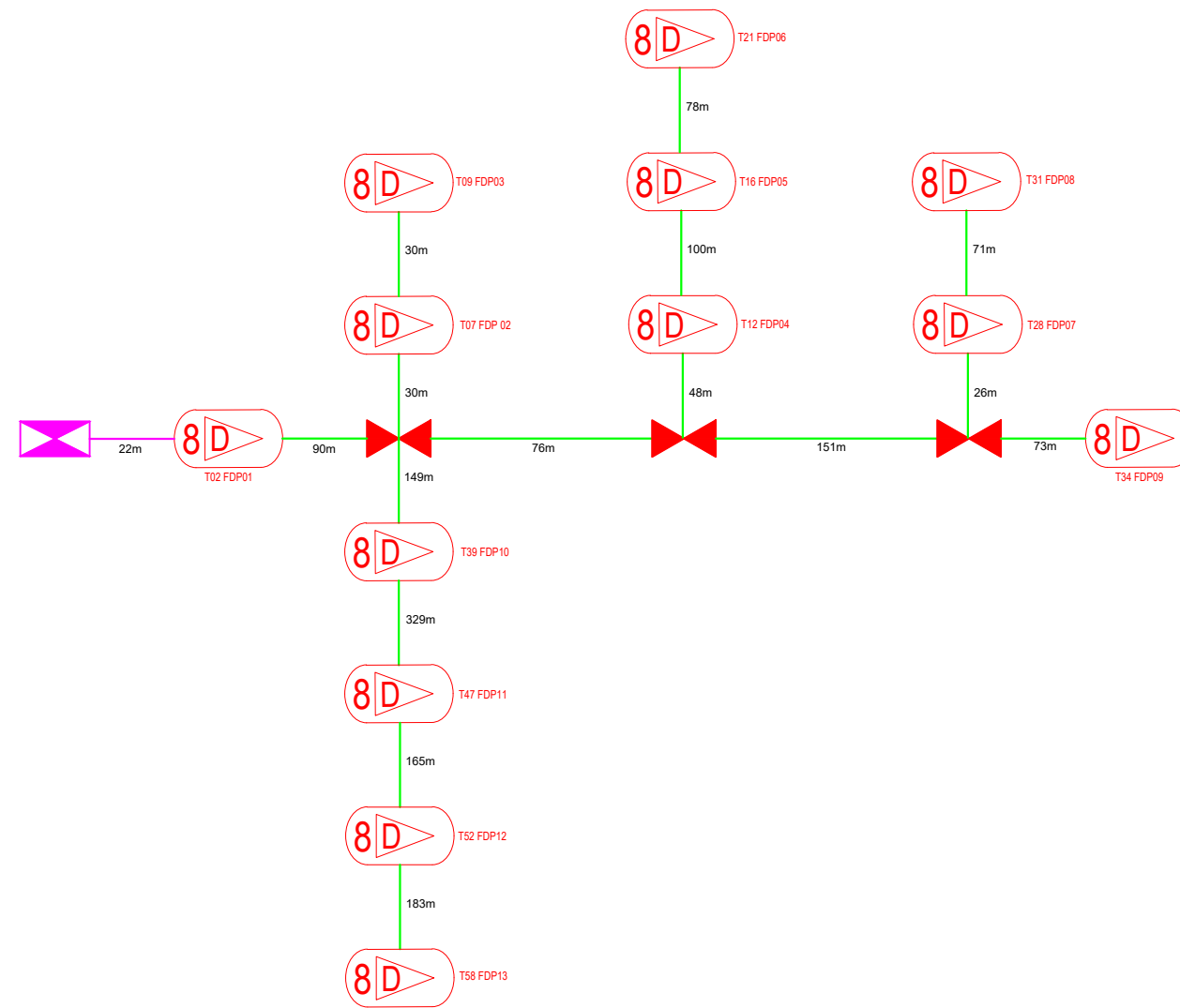
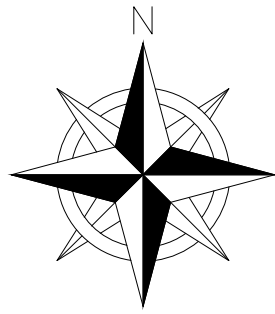

12C FOC		Installed 1:4 / 1:8 splitter		Existing TNB Pole		Pole Ring	13	Micro-Trenching (Meter)	#	Active Outdoor Numbering	CL01	Closure NO.
24C FOC	3440m	FDC	1	Installed Riser		New Manhole (PIT)		Temporary Infra (Meter)	NBD#	FDC NO.	DP1	FDP NO.
48C FOC		Closure	3	FDP with (1:8) splitter	13	New Manhole(JRC7)	2	FDP Boundary	MH1	MH NO.		
96C FOC		Installed Pole (9m)	2	Suspension	35	Existing Manhole		HDD (Meter)	TKS-1	Existing TNB Pole NO.		
144C FOC		Installed Pole (7.5m)	58	Tension	44	Loop / Coil (Meter)		Open Cut (Meter)	T01	New Pole NO.		

ACTUAL HOMEPASS :

KEY PLAN:

PROJECT OWNER:

MAIN CONTRACTOR:

SUB-CONTRACTOR:

WABTECH SDN BHD (1398387-X)  
 101-1, JALAN METRO SENDAYAN 2,  
 METRO SENDAYAN, BANDAR SRI SENDAYAN  
 71950 SEREMBAN, NEGERI SEMBILAN.  
 TEL: +606-6020063  
 FAX: (60) 6 602 0063  
 E-MAIL : wabte@wabtech.solutions WEBSITE: www.wabtech.solutions

PROJECT TITLE:

**CONTRACT FOR THE PROVISION OF SUPPLY, INSTALLATION AND COMMISSIONING OF FTTX NETWORK INFRASTRUCTURE - POP 2 PROJECT (D-SIDE) - FOR ABA7008 - SK LENGGONG**

DRAWING TITLE:

**CONSTRUCTION DRAWING - SK LENGGONG**

PROJECT PHASE:  
**SK LENGGONG**

Design By : M. AFIQ HAKIMI	Date : 29 NOVEMBER 2024
Drawn By : M. AFIQ HAKIMI	Scale :
Checked By : (WABTECH PIC)	Job Number :
DRAWING NUMBER :	Sheet : 1 / 1
THIS PRINT AND ITS COPYRIGHT ARE THE PROPERTY OF WABTECH SDN BHD	
Size :	