







PELAN TAPAK

SCALE : 1 : 150

LEGEND

-  PROPOSED JC9/C MANHOLE
-  PROPOSED JB30 MANHOLE C/W 7E COVER (SHALL BE INSTALLED ON THE ROAD SHOULDER)
-  8 PAIRS GROUND D.P. INSTALLED ONTO CONCRETE PEDESTAL ON TOP OF JB30 MANHOLE ON ROAD SHOULDER (PLINTH PEDESTAL BY DEVELOPER)
-  PROPOSED 2-WAY 100mmØ TELEPHONE PIPE
-  1 WAY 50mmØ BLACK POLY PIPE C/W DROP FIBER CABLE
-  JUNCTION PIT 150x150x150(D) C/W R.C. SLAB COVER
-  EXISTING TEL. MANHOLE

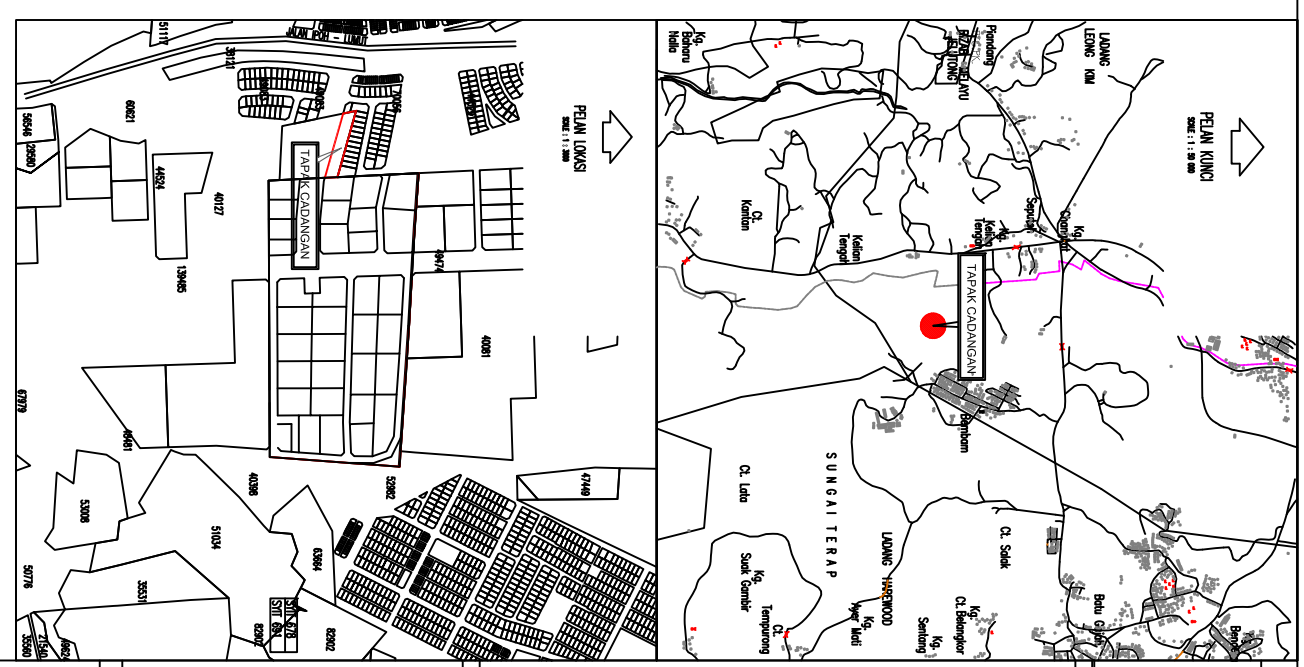
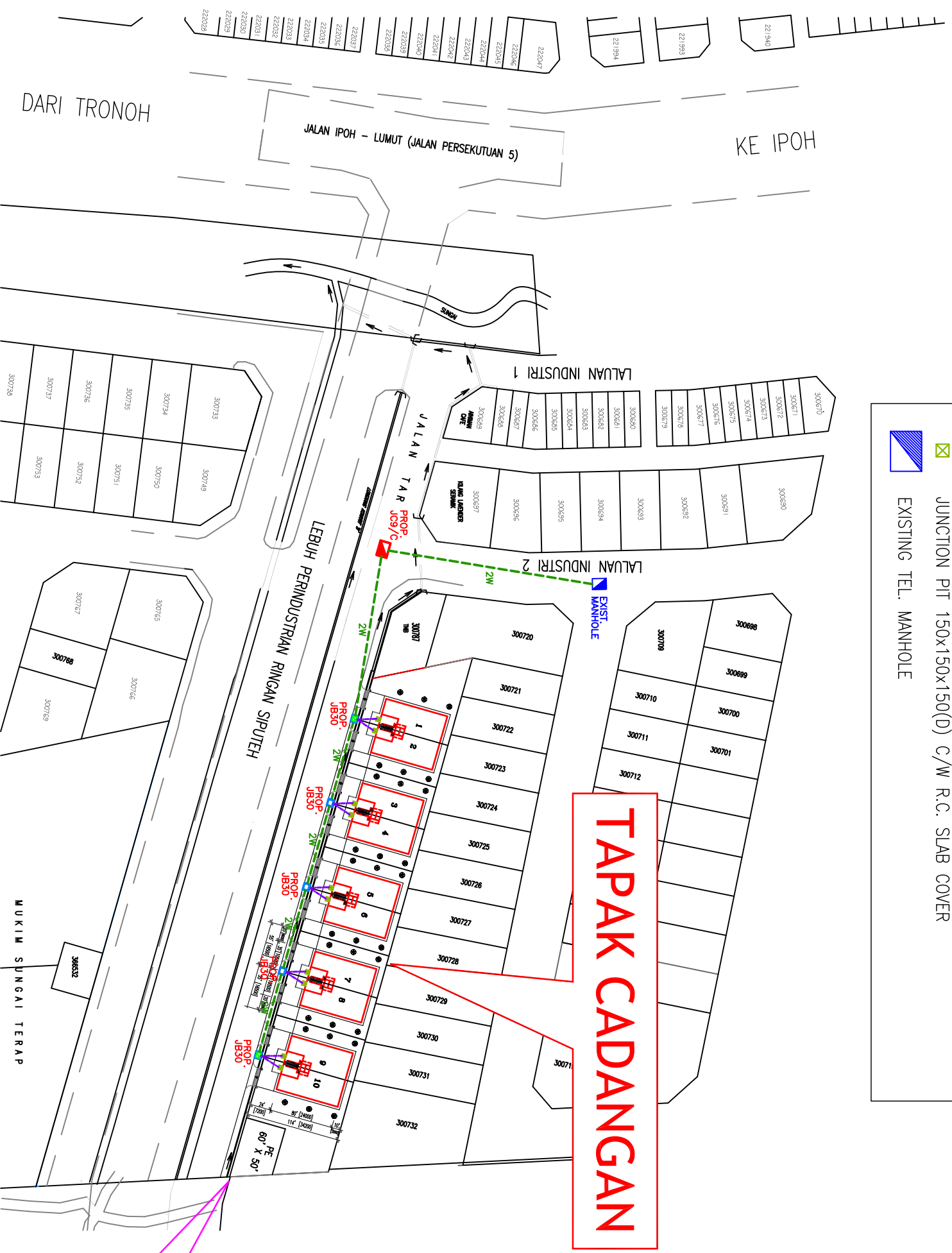

LAT: 4° 27' 14.6" N
 (4.454041)
 LON: 101° 00' 01.3" E
 (101.000354)

DRAWING NO		PEC/C/PK/ND-P/R/9/282/TEL1		REV. NO.		2	
DRAWN BY	SOO	CHECKED BY	EDWIN	DATE	OCT 2025	APPROVED	R. LEW Y.T.
<p>OWNER TANDAITANGSIAN PEKALIK</p> <p>MOND. AZAN BIN ABUL HAWD Pengerusi PERBADANAN KEMAJUAN NEGERI PERAK PERUMAHAN KEMAJUAN NEGERI PERAK Hal Ehsan, Tronoh dan Harau 31400 IPOH, PERAK DARUL RIDZUAN. NO. TEL: 605-5018888 NO.FAK: 605-5019999</p> <p>TANDAITANGSIAN PEKALIK</p> <p>ABDUL RAHIM BIN BOURABOUR No. K/P : 60202-06-053 No. P/P : 60202-06-053 PERAK INDUSTRIAL RESOURCES Sdn. Bhd. LEBEL 6, PERAK TERNO, KAMPUS 1, JALAN KEMAMUKAN 30020 IPOH, PERAK DARUL RIDZUAN. NO. TEL: 605-5019596 NO.FAK: 605-5019399</p> <p>PROJECT TITLE CADANGAN MEMBINA 10 UNIT KILANG PELABAT BERKEMBAR 1 1/2 DI ATAS TANAH KERAMAKAN PLOT NO. 1 HINGGA 10, LEBUH PERINDUSTRIAN RINGAN SIPUTEH, KAWASAN PERINDUSTRIAN RINGAN SIPUTEH, MUKIM SUNGAI TERAP, DAERAH KINTA, PERAK DARUL RIDZUAN. UNTUK PERBADANAN KEMAJUAN NEGERI PERAK.</p> <p>DRAWING TITLE KEY, SITE & LOCATION PLAN - EXTERNAL TEL. INFRA. WORKS</p> <p>M & E CONSULTANT:  PRIMEEDGE CONSULT (INCORPORATED) M&E Consulting Engineers - Major Firming M&E B-1-14, INTAN BUSINESS CENTRE 2, LEBUH JERDAN POH, BANDAR BARU MERDAN IPOH, 31400 IPOH, PERAK DARUL RIDZUAN. Tel : 05 - 6468080 Fax : 05 - 6468080 email: primeedgeconsult@yahoo.com</p> <p>ENGINEER'S SIGNATURE:</p>							

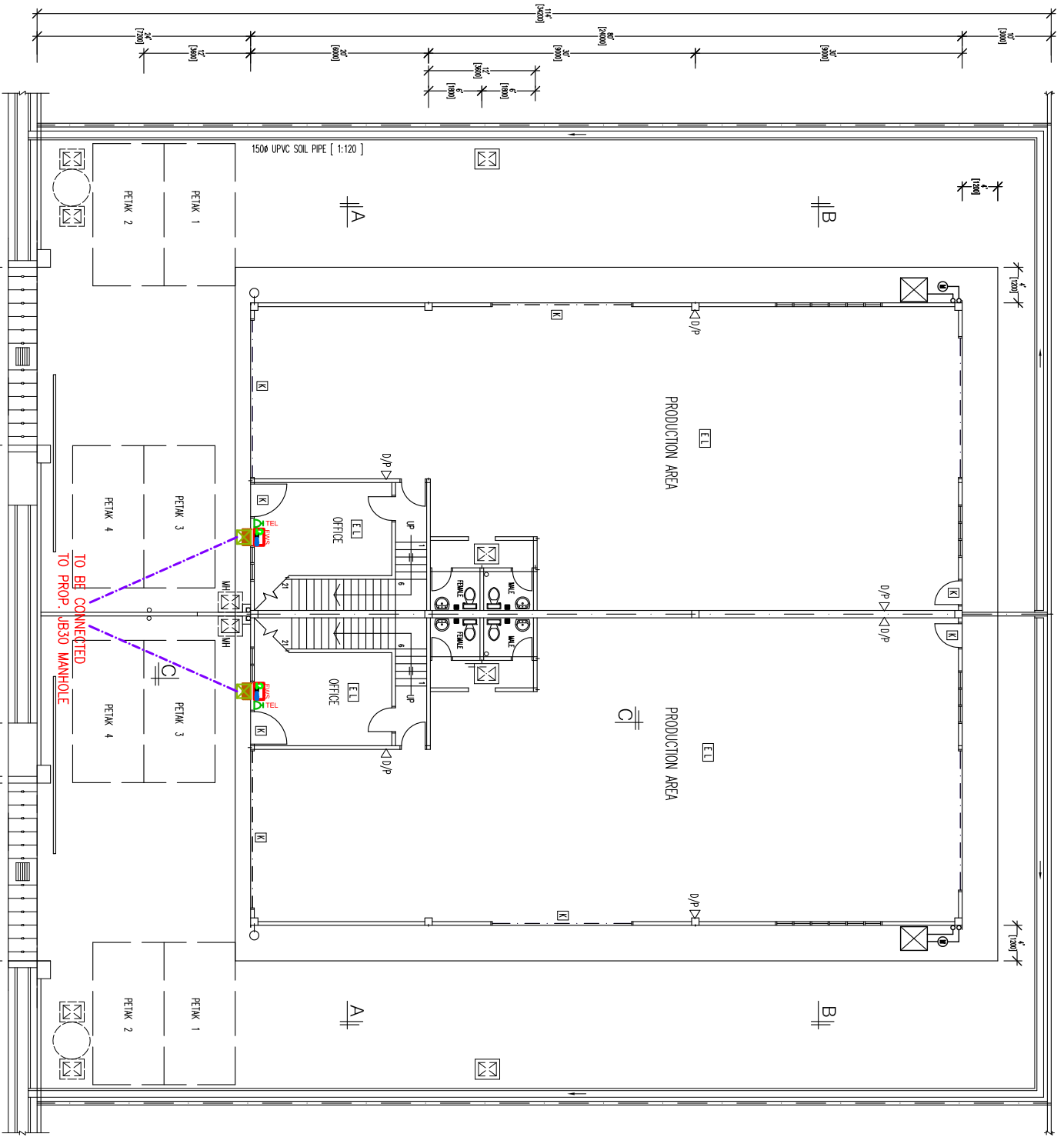
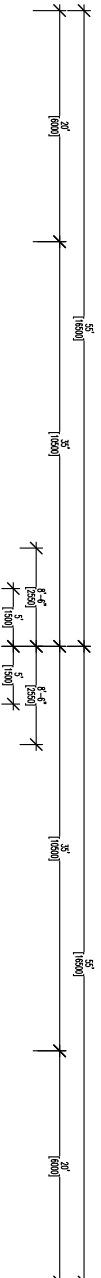
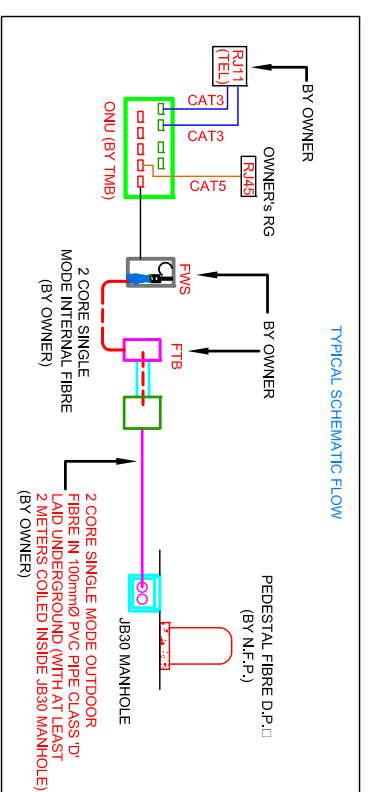

LEGEND	
	PROPOSED FIBRE WALL SOCKET (FWS)
	JUNCTION PIT 150x150x150(D) C/W R.C. SLAB COVER
	1 WAY 50mmØ BLACK POLY PIPE C/W DROP FIBER CABLE
	RJ11 FOR TELEPHONE

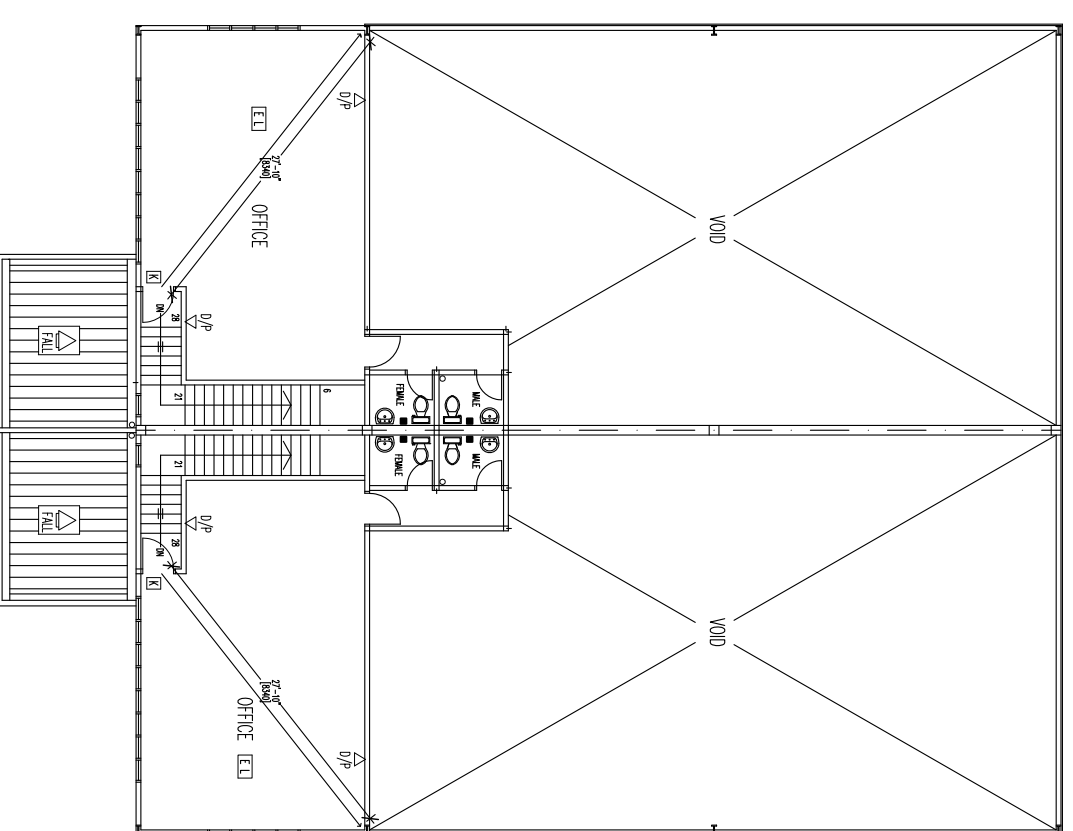
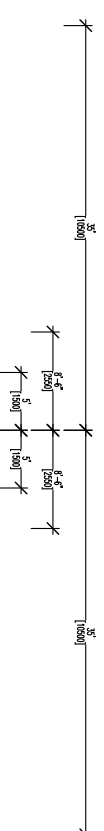

NOTES

OWNER
TANDATANSAN PERMAJU

MHD. AZAN BIN ABUL HAWD
 Pengerusi
PERBADANAN KEMAJUAN NEGERI PERAK
 PERBADANAN KEMAJUAN NEGERI PERAK
 Hdi Ehsan, Tanah dan Hutan
 Pengerusi
PERBADANAN KEMAJUAN NEGERI PERAK
 BANDAR MERU BAWA, 30020 IPOH, PERAK DARUL RIDZUAN,
 NO. TEL: 605-5019888 NO.FAK: 605-5019899

ABUL RAHIM BIN BAKARABUWARI
 No. K/P : 602520-08-0504
 No. P/P : 602520-08-0504
PERAK INDUSTRIAL RESOURCES Sdn. Bhd.
 BANDAR MERU BAWA, 30020 IPOH, PERAK DARUL RIDZUAN,
 NO. TEL: 605-5019596 NO.FAK: 605-5019399

PROJECT TITLE
 CADANGAN MEMBINA 10 UNIT KILANG PELABAT BERKEMBAR 1 1/2 DI ATAS TANAH KERAJAAN PLOT NO. 1 HINGGA 10, LEBOH PERINDUSTRIAN RINGAN SIPUTEH, KAWASAN PERINDUSTRIAN RINGAN SIPUTEH, MUKIM SUNGAI TERAP, DAERAH KINTA, PERAK DARUL RIDZUAN,
 UNTUK PERBADANAN KEMAJUAN NEGERI PERAK.

DRAWING TITLE
 INTERNAL TELEPHONE LAYOUT

M & E CONSULTANT:

 PRIMEEDGE CONSULT
 (INCORPORATED)
 B-1-14, INTAN BUSINESS CENTRE 2,
 LEBOH MERDAN POH, BANDAR BARU MERDAN POH,
 31400 IPOH, PERAK DARUL RIDZUAN.
 Tel : 05 - 6468080
 Fax : 05 - 6468080
 email: primeedgeconsult@yahoo.com

ENGINEER'S SIGNATURE:

DRAWN BY	SOO	CHECKED BY	EDWIN
SCALE	AS SHOWN	APPROVED	RI LIEW Y.T.
DATE	OCT 2025		
DRAWING NO	PEC/C/PKANP-PIR/9282/TEL2	REV. NO.	1